

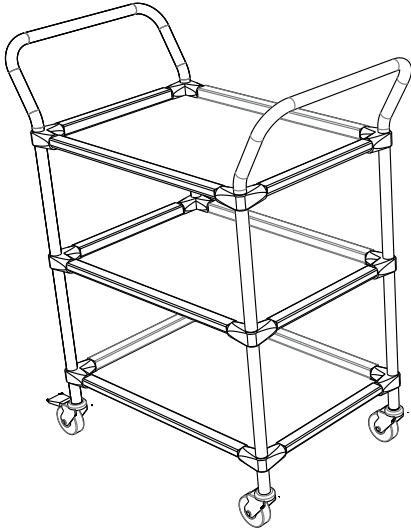

VIKING



2x

TT-XX.00.01

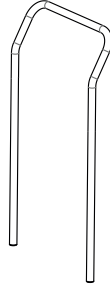

3x

TT-XX.00.01

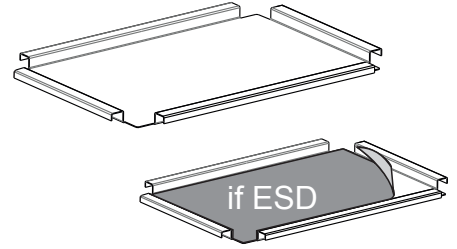

6x



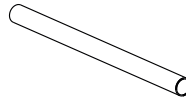



TT-XX.00.03

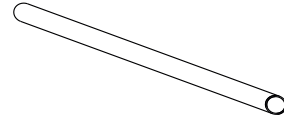

6x

TT-XX.00.02



4x 1.1.912.10x20 	4x 1.4.127.10 	12x 2.4.3.1 	2x 2.2.1S if ESD 2.2.5S 	2x 2.2.2 if ESD 2.2.6 	1x 3.1.1.1 	1x 3.1.1.2 
---	---	--	--	--	--	--

1

x2

2.4.3.1

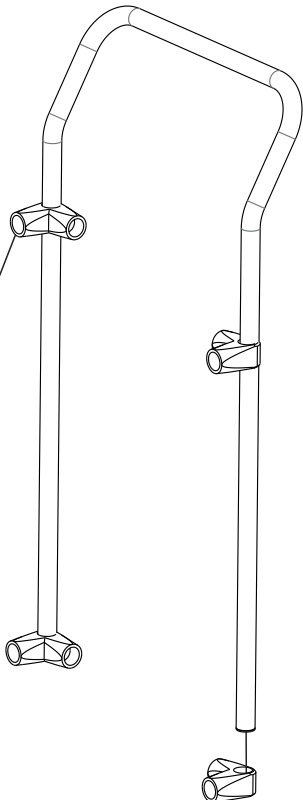

2 x3

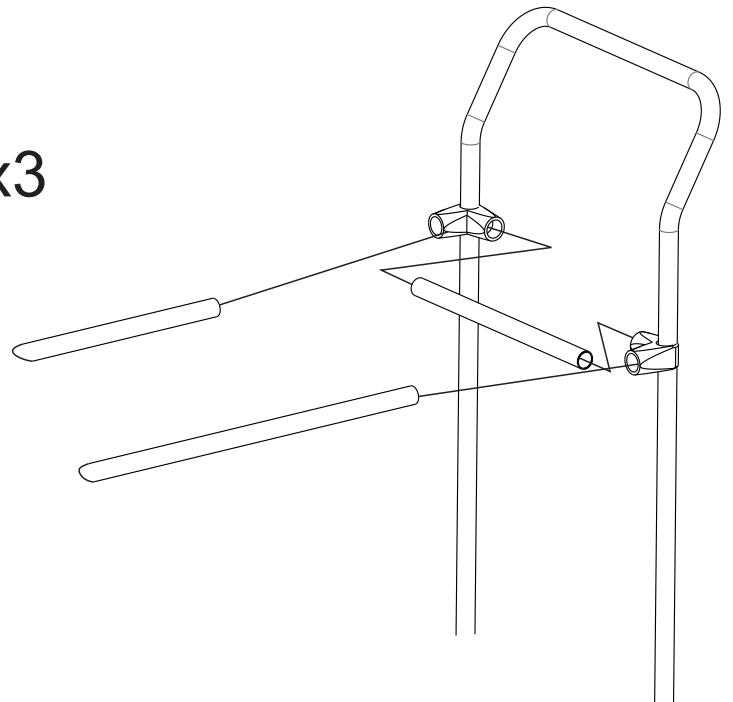

3

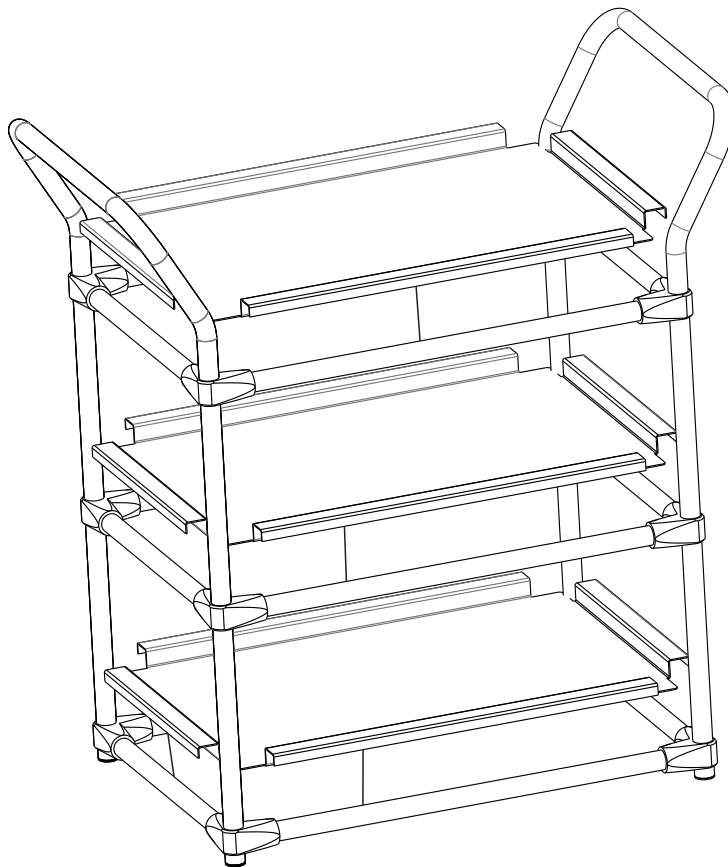

4



2.2.1S

1.4.127.10

1.1.912.10x16

2.2.2

5



ESD

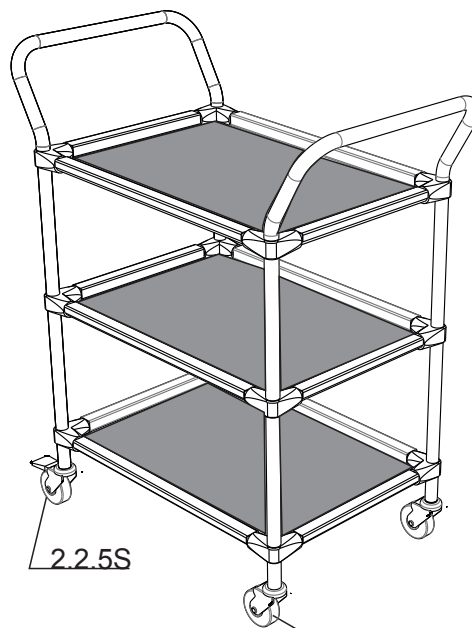

2.2.5S

2.2.6